

**Description**

The FH1908B uses advanced trench technology and design to provide excellent  $R_{DS(ON)}$  with low gate charge. This device is suitable for use in PWM, load switching and general purpose applications.

**Application**

- Power switching application
- Hard Switched and High Frequency Circuits
- Uninterruptible Power Supply

**General Features**

- $V_{DS} = 80V, I_D = 85A$   
 $R_{DS(ON)} < 7.8m\Omega @ V_{GS}=10V$  (Typ:  $6.2m\Omega$ )
- Special process technology for high ESD capability
- Special designed for Convertors and power controls
- High density cell design for ultra low  $R_{dson}$
- Fully characterized Avalanche voltage and current
- Good stability and uniformity with high  $E_{AS}$
- Excellent package for good heat dissipation

**TO-263**

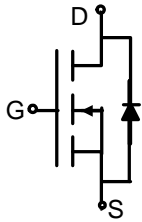

Schematic diagram

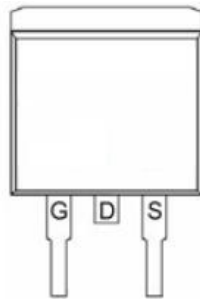

Marking and pin assignment

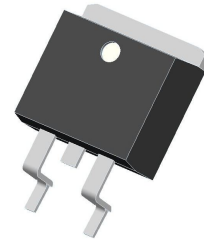

TO-263 top view

**Absolute Maximum Ratings (TA=25°C unless otherwise noted)**

Parameter	Symbol	Limit	Unit
Drain-Source Voltage	$V_{DS}$	80	V
Gate-Source Voltage	$V_{GS}$	$\pm 20$	V
Drain Current-Continuous	$I_D$	85	A
Drain Current-Continuous( $T_C=100^\circ C$ )	$I_D(100^\circ C)$	62	A
Pulsed Drain Current	$I_{DM}$	340	A
Maximum Power Dissipation	$P_D$	175	W
Peak diode recovery voltage	$dv/dt$	15	V/ns
Derating factor		1.13	W/°C
Single pulse avalanche energy <sup>(Note 5)</sup>	$E_{AS}$	580	mJ
Operating Junction and Storage Temperature Range	$T_J, T_{STG}$	-55 To 175	°C

**Thermal Characteristic**

Thermal Resistance, Junction-to- Case <sup>(Note 2)</sup>	$R_{\theta jc}$	0.88	°C/W
---	-----------------	------	------

**Electrical Characteristics ( $T_A=25^\circ\text{C}$  unless otherwise noted)**

Parameter	Symbol	Condition	Min	Typ	Max	Unit
<b>Off Characteristics</b>						
Drain-Source Breakdown Voltage	$BV_{DSS}$	$V_{GS}=0V, I_D=250\mu A$	80	-	-	V
Zero Gate Voltage Drain Current	$I_{DSS}$	$V_{DS}=60V, V_{GS}=0V$	-	-	1	$\mu A$
Gate-Body Leakage Current	$I_{GSS}$	$V_{GS}=\pm 20V, V_{DS}=0V$	-	-	$\pm 100$	nA
<b>On Characteristics</b> <sup>(Note 3)</sup>						
Gate Threshold Voltage	$V_{GS(th)}$	$V_{DS}=V_{GS}, I_D=250\mu A$	2	3	4	V
Drain-Source On-State Resistance	$R_{DS(on)}$	$V_{GS}=10V, I_D=30A$	-	6.2	7.8	m $\Omega$
Forward Transconductance	$g_{FS}$	$V_{DS}=5V, I_D=30A$	-	60	-	S
<b>Dynamic Characteristics</b> <sup>(Note 4)</sup>						
Input Capacitance	$C_{iss}$	$V_{DS}=25V, V_{GS}=0V,$ $F=1.0\text{MHz}$		4030		PF
Output Capacitance	$C_{oss}$			348		PF
Reverse Transfer Capacitance	$C_{rss}$			290		PF
<b>Switching Characteristics</b> <sup>(Note 4)</sup>						
Turn-on Delay Time	$t_{d(on)}$	$V_{DD}=30V, I_D=2A, R_L=15\Omega$ $V_{GS}=10V, R_G=2.5\Omega$		17.8		nS
Turn-on Rise Time	$t_r$			11.8		nS
Turn-Off Delay Time	$t_{d(off)}$			56		nS
Turn-Off Fall Time	$t_f$			14.6		nS
Total Gate Charge	$Q_g$	$V_{DS}=30V, I_D=30A,$ $V_{GS}=10V$		100		nC
Gate-Source Charge	$Q_{gs}$			20		nC
Gate-Drain Charge	$Q_{gd}$			30		nC
<b>Drain-Source Diode Characteristics</b>						
Diode Forward Voltage <sup>(Note 3)</sup>	$V_{SD}$	$V_{GS}=0V, I_S=40A$	-	-	1.2	V
Diode Forward Current <sup>(Note 2)</sup>	$I_S$		-	-	85	A
Reverse Recovery Time	$t_{rr}$	$T_j=25^\circ\text{C}, I_{SD}=40A, V_{GS}=0V$			36	nS
Reverse Recovery Charge	$Q_{rr}$	$T_j=25^\circ\text{C}, I_F=75A, di/dt=100A/\mu s$			56	nC
Forward Turn-On Time	$t_{on}$	Intrinsic turn-on time is negligible (turn-on is dominated by LS+LD)				

**Notes:**

1. Repetitive Rating: Pulse width limited by maximum junction temperature.
2. Surface Mounted on FR4 Board,  $t \leq 10$  sec.
3. Pulse Test: Pulse Width  $\leq 300\mu s$ , Duty Cycle  $\leq 2\%$ .
4. Guaranteed by design, not subject to production
5. EAS condition:  $T_j=25^\circ\text{C}, V_{DD}=50V, V_G=10V, L=0.5\text{mH}, I_D=62A$

**Test circuit**

**1)  $E_{AS}$  test Circuits**

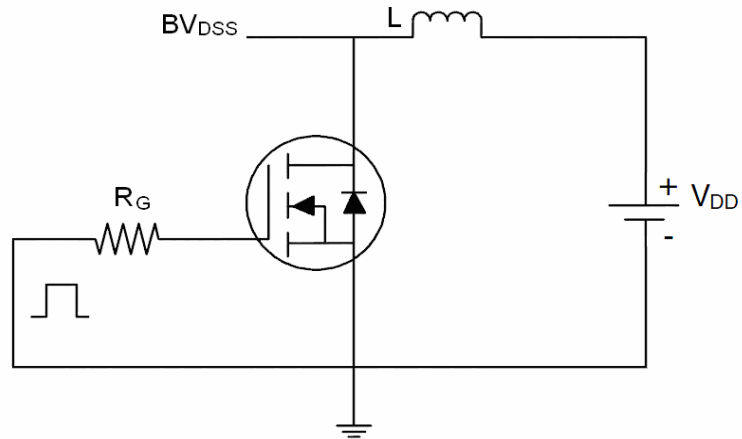

**2) Gate charge test Circuit**

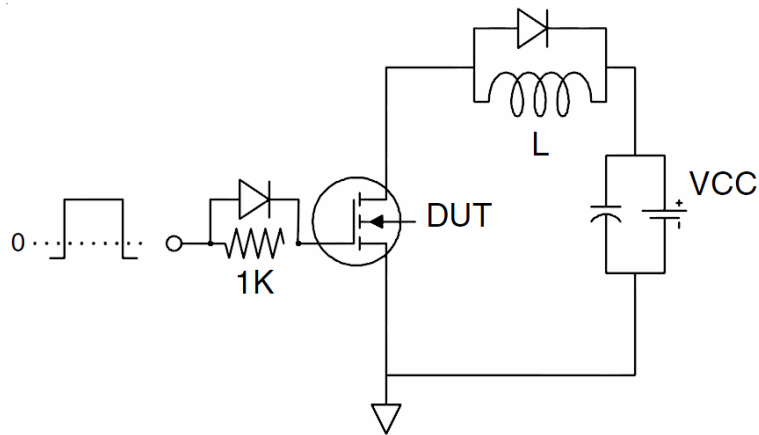

**3) Switch Time Test Circuit**

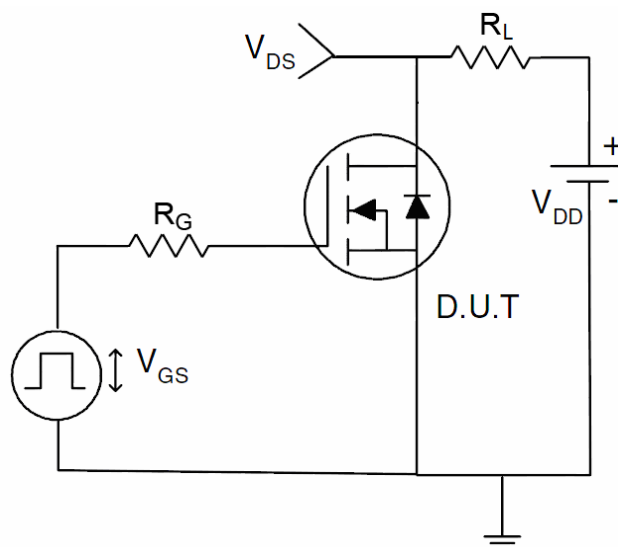

Typical Electrical and Thermal Characteristics (curves)

Figure1. Safe operating area

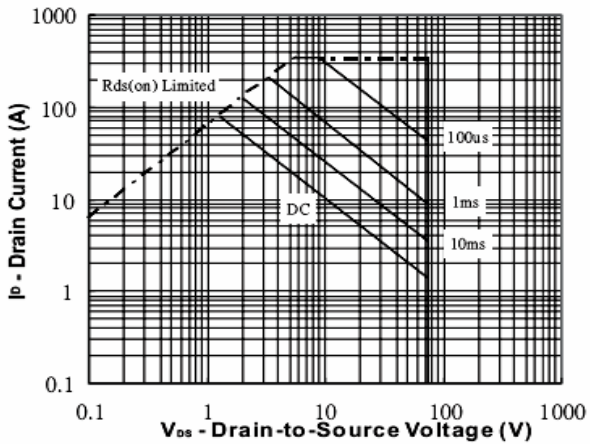

Figure2. Source-Drain Diode Forward Voltage

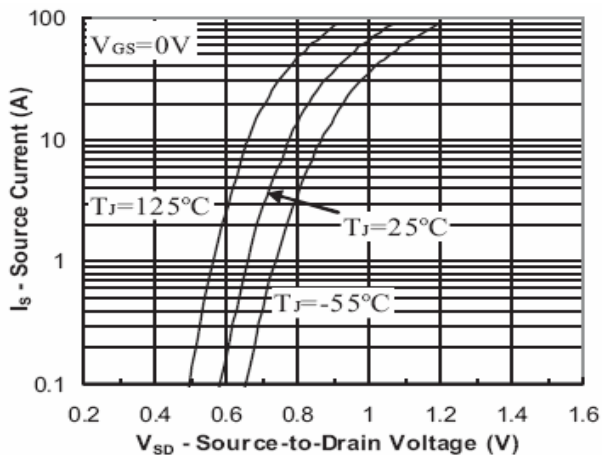

Figure3. Output characteristics

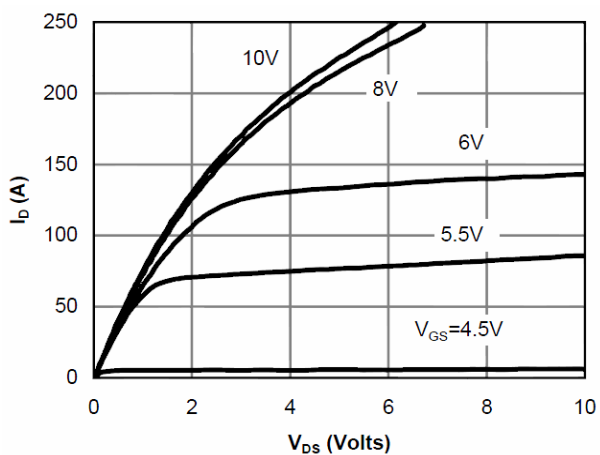

Figure4. Transfer characteristics

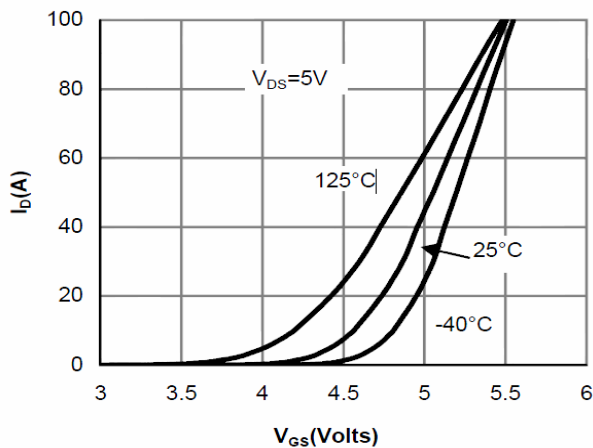

Figure5. Static drain-source on resistance

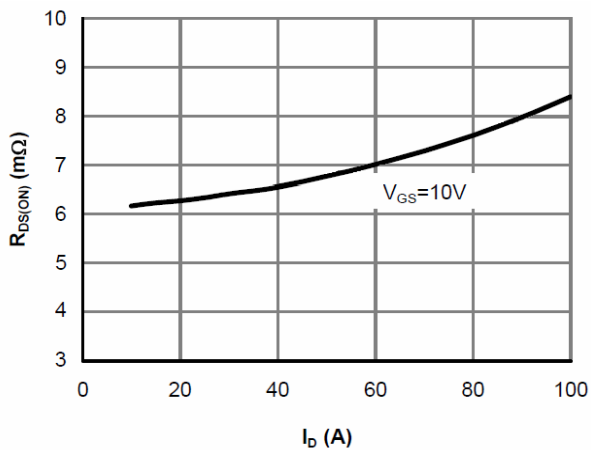

Figure6.  $R_{DS(ON)}$  vs Junction Temperature

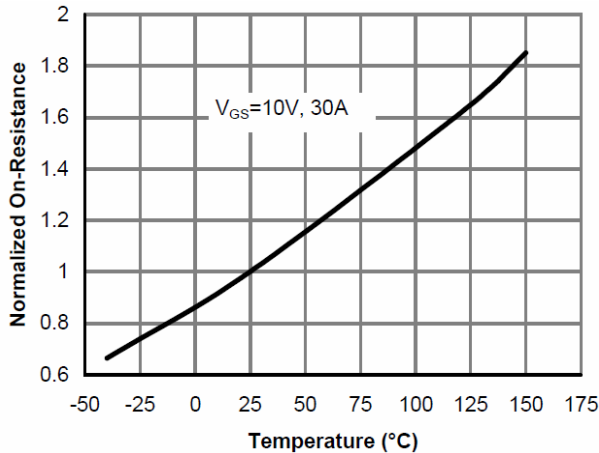

Figure7.  $BV_{DSS}$  vs Junction Temperature

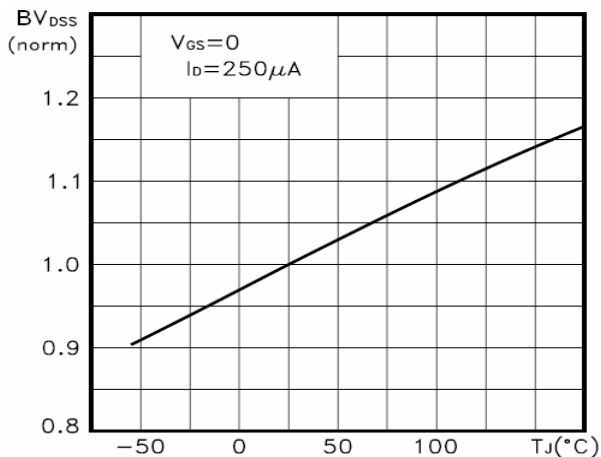

Figure8.  $V_{GS(th)}$  vs Junction Temperature

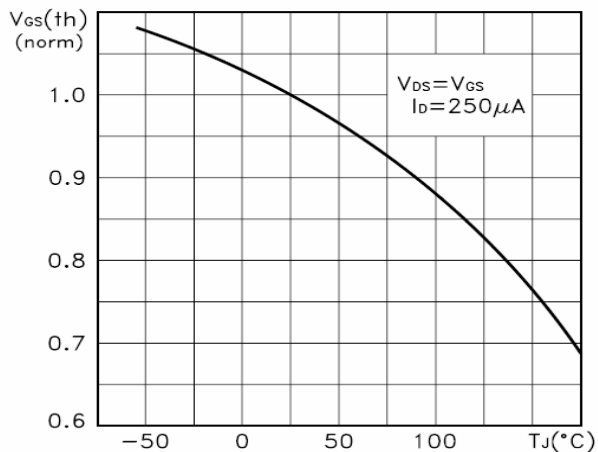

Figure9. Gate charge waveforms

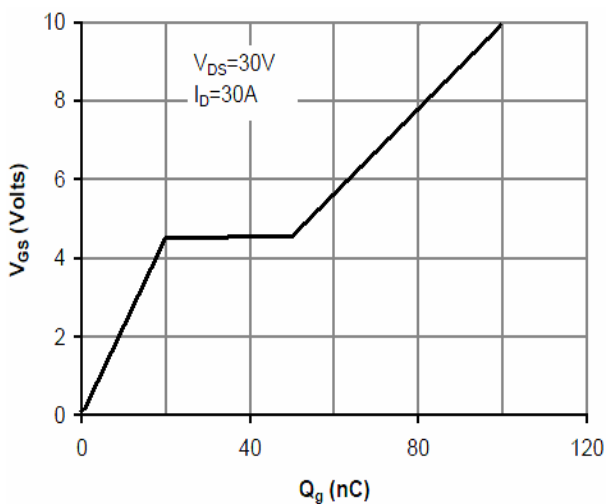
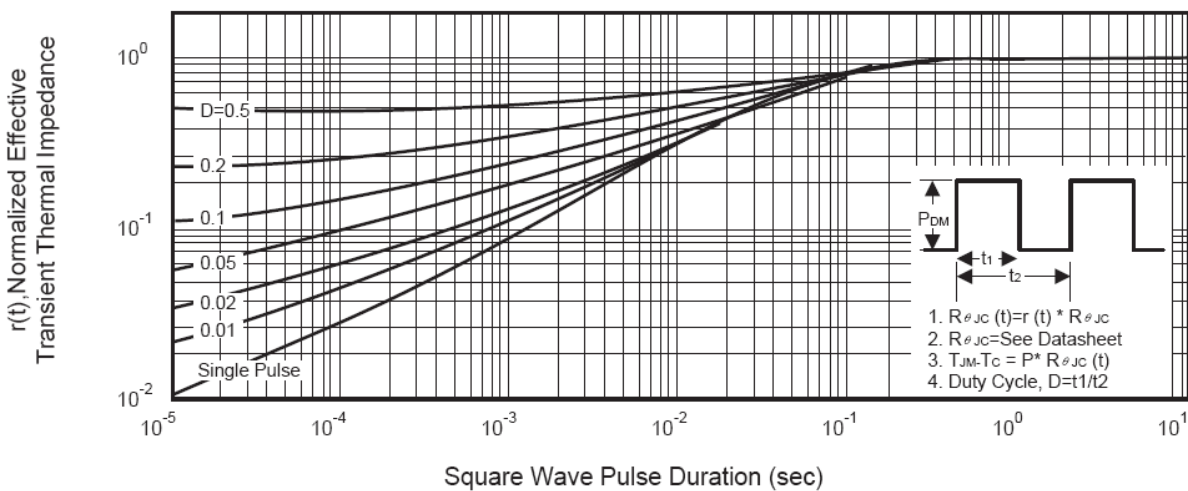
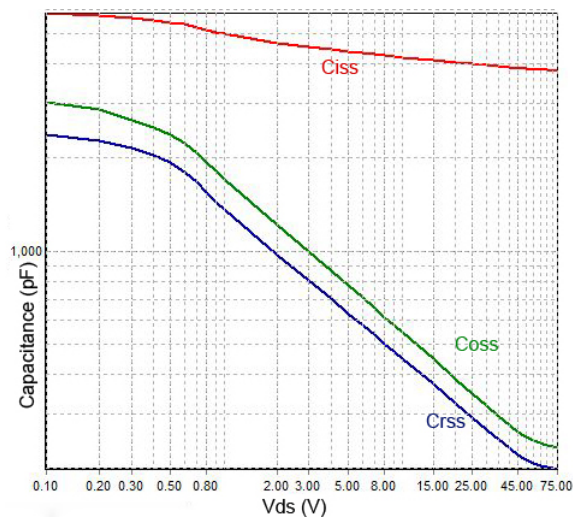
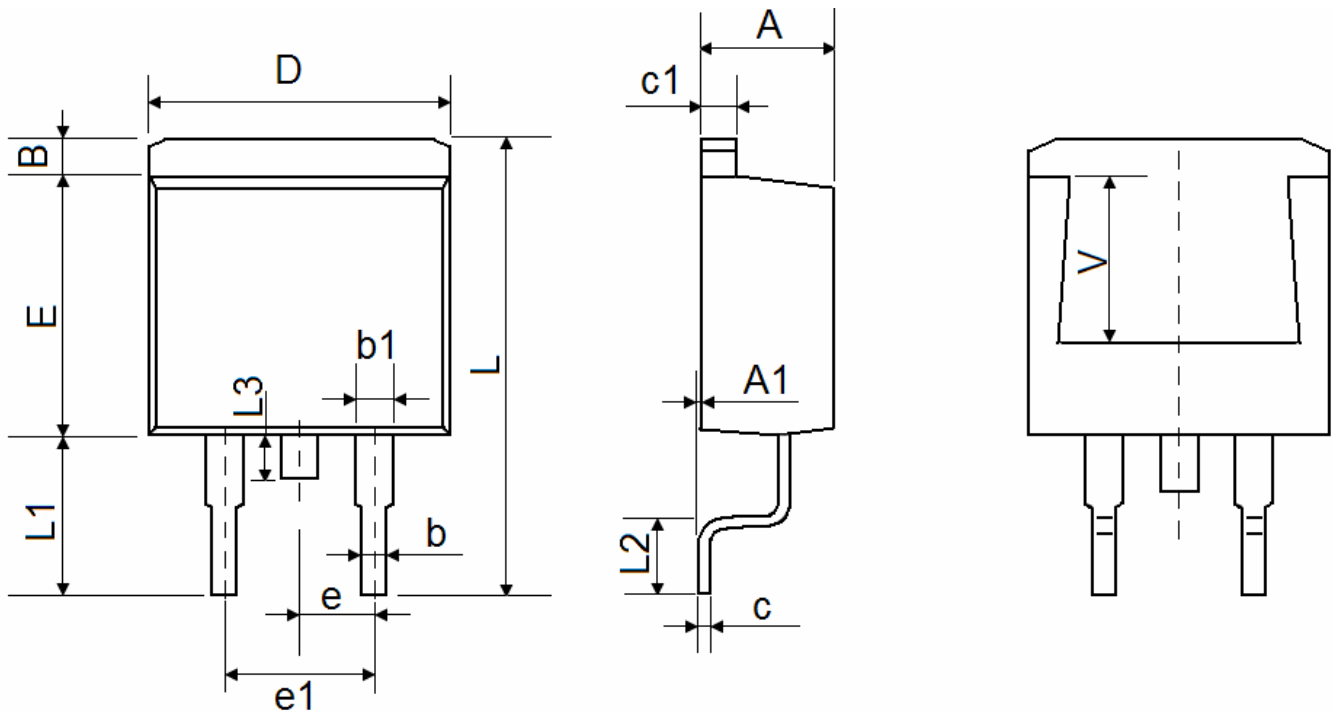

Figure10. Capacitance



## Package Information : TO-263



Symbol	Dimensions In Millimeters		Dimensions In Inches	
	Min.	Max.	Min.	Max.
A	4.470	4.670	0.176	0.184
A1	0.000	0.150	0.000	0.006
B	1.170	1.370	0.046	0.054
b	0.710	0.910	0.028	0.036
b1	1.170	1.370	0.046	0.054
c	0.310	0.530	0.012	0.021
c1	1.170	1.370	0.046	0.054
D	10.010	10.310	0.394	0.406
E	8.500	8.900	0.335	0.350
e	2.540 TYP.		0.100 TYP.	
e1	4.980	5.180	0.196	0.204
L	15.050	15.450	0.593	0.608
L1	5.080	5.480	0.200	0.216
L2	2.340	2.740	0.092	0.108
L3	1.300	1.700	0.051	0.067
V	5.600 REF		0.220 REF	