

FH3401A

P-Channel Enhancement Mode MOSFET

Description

The FH3401A is the P-Channel enhancement mode MOSFET in a plastic package (SOT-23) using the Trench technology.

Applications

- ◆ High Speed Switch
- ◆ DC-DC Converters
- ◆ Lithium-Ion Battery

Features

- ◆ $V_{DS} = -30V$; $I_D = -5.3A$
 $R_{DS(ON)}(Typ.) = 29m\Omega$ @ $V_{GS} = -10V$
 $R_{DS(ON)}(Typ.) = 34m\Omega$ @ $V_{GS} = -4.5V$
 $R_{DS(ON)}(Typ.) = 54m\Omega$ @ $V_{GS} = -2.5V$
- ◆ LogicLevelCompatible
- ◆ SMDPackage(SOT-23)
- ◆ TrenchTechnology
- ◆ FastSwitching

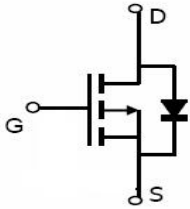

Schematic diagram

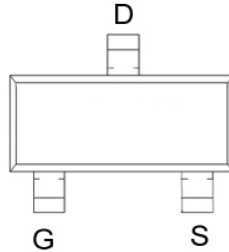

Marking and Pin Assignment

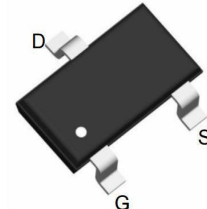

SOT-23 top view

■ Absolute Maximum Ratings ($T_A = 25^\circ C$, unless otherwise specified)

Parameter	Symbol	Typical	Unit
Drain-Source Voltage	V_{DS}	-30	V
Gate-Source Voltage	V_{GS}	± 12	V
Continuous Drain Current ($T_J = 150^\circ C$)	I_D	-5.3	A
Pulsed Drain Current	I_{DM}	-34	A
Power Dissipation	P_D	1.25	W
Operating Junction and Storage Temperature Range	T_J, T_{STG}	-55 to 150	$^\circ C$
Thermal Resistance-Junction to Ambient (Note 1)	R_{thJA}	100	$^\circ C/W$

■ Electrical Characteristics (T_A = 25°C, unless otherwise specified)

Parameter	Symbol	Test Conditions	Min	Typ	Max	Unit
Static						
Drain-source Breakdown Voltage	BV _{DSS}	V _{GS} = 0V, I _D = -250μA	-30			V
Gate Threshold Voltage	V _{GS(th)}	V _{DS} = V _{GS} , I _D = -250μA	-0.70	-0.96	-1.30	V
Gate-Body Leakage Current	I _{GSS}	V _{DS} = 0V, V _{GS} = ±12V			±100	nA
Zero Gate Voltage Drain Current	I _{DSS}	V _{DS} = -30V, V _{GS} = 0V			-1	μA
Drain-Source On-Resistance	R _{DS(on)}	V _{GS} = -10V, I _D = -4.2A		29	35	mΩ
		V _{GS} = -4.5V, I _D = -4.0A		34	42	
		V _{GS} = -2.5V, I _D = -2.0A		54	65	
Forward Transconductance	g _{FS}	V _{DS} = -5V, I _D = -5.0A	8	13		S
Diode Forward Voltage (Note 2)	V _{SD}	V _{GS} = 0V, I _S = -1.0A			-1.0	V
Diode Forward Current (Note 1)	I _S				-2.2	A
Dynamic						
Total Gate Charge	Q _g	V _{DS} = -15V, V _{GS} = -10V, I _D = -1A		29.6		nC
Gate-Source Charge	Q _{gs}			3.2		
Gate-Drain Charge	Q _{gd}			2.72		
Input Capacitance	C _{iss}	V _{DS} = -15V, V _{GS} = 0V, f = 1MHz		1475		pF
Output Capacitance	C _{oss}			195		
Reverse Transfer Capacitance	C _{rss}			160		
Switching						
Turn-On Delay Time	t _{d(on)}	V _{DD} = -15V, R _L = 15Ω, I _D = -1A, V _{GS} = -4.5V, R _{GEN} = 10Ω		8		nS
Rise Time	t _r			3		
Turn-Off Delay Time	t _{d(off)}			35		
Fall-Time	t _f			10		

Note: 1. Mounted on FR4 board, t ≤ 5sec.
2. Pulse Test: Pulse Width ≤ 300μs, Duty Cycle ≤ 2%.

■ Typical Electrical and Thermal Characteristics

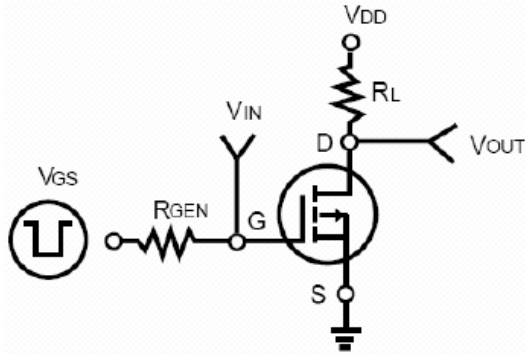

Figure 1: Switching Test Circuit

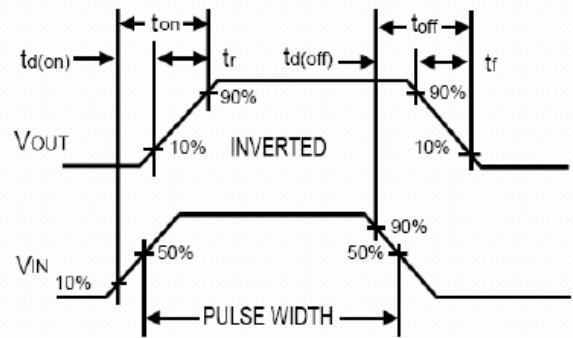

Figure 2: Switching Waveforms

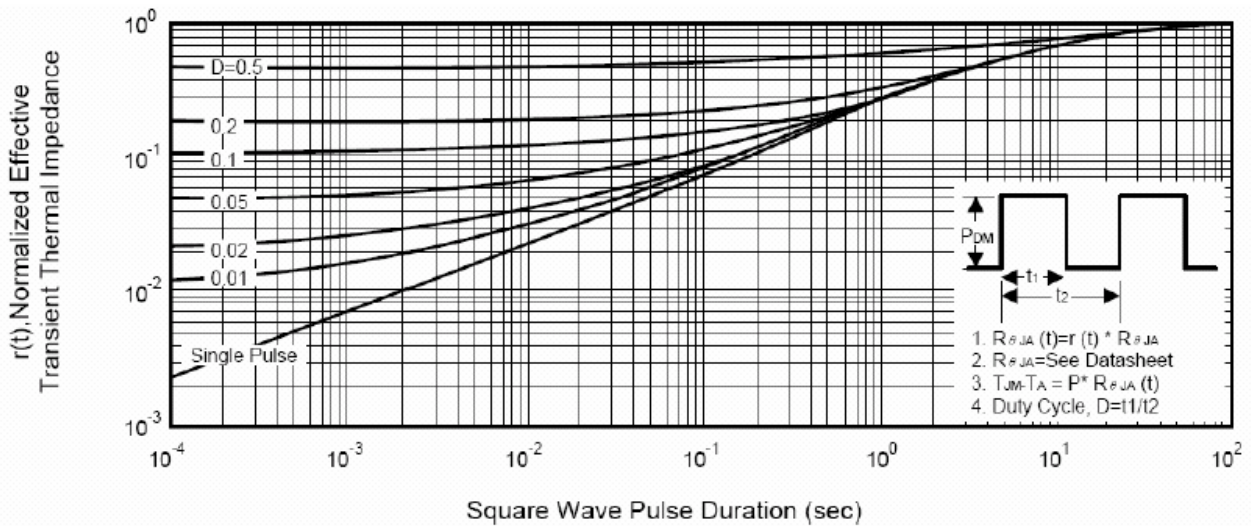
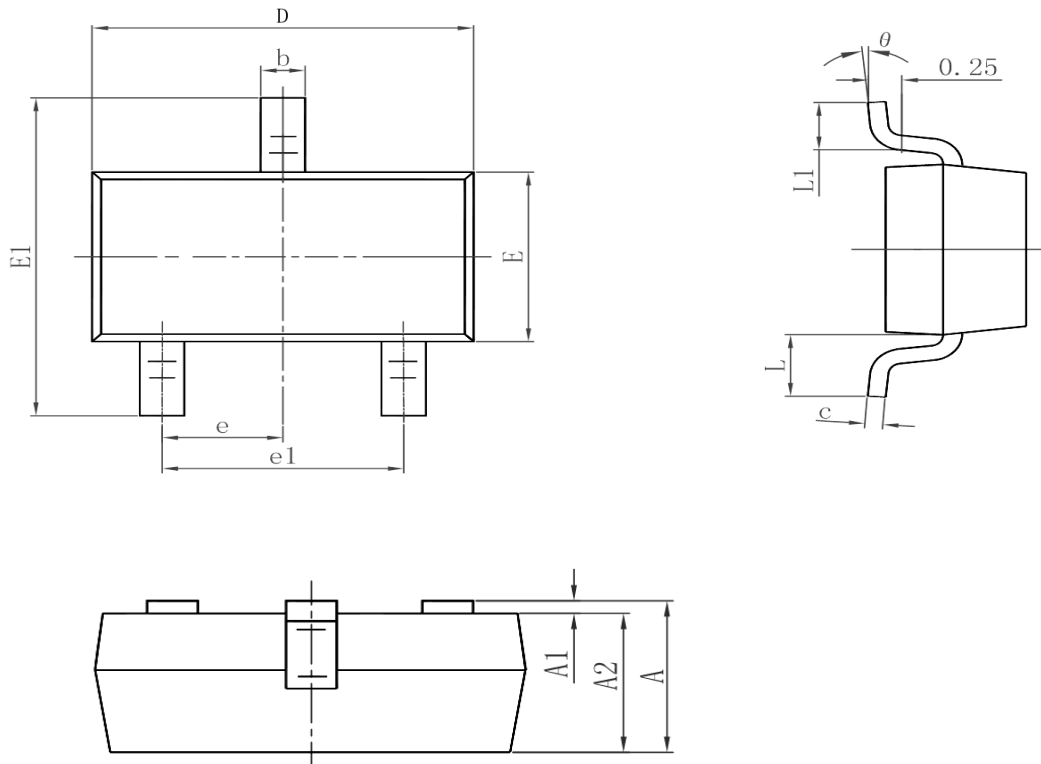

Figure 3: Normalized Maximum Transient Thermal Impedance

■ Package Dimensions : SOT-23



Symbol	Dimensions In Millimeters		Dimensions In Inches	
	Min.	Max.	Min.	Max.
A	0.900	1.150	0.035	0.045
A1	0.000	0.100	0.000	0.004
A2	0.900	1.050	0.035	0.041
b	0.300	0.500	0.012	0.020
c	0.080	0.150	0.003	0.006
D	2.800	3.000	0.110	0.118
E	1.200	1.400	0.047	0.055
E1	2.250	2.550	0.089	0.100
e	0.950 TYP.		0.037 TYP.	
e1	1.800	2.000	0.071	0.079
L	0.550 REF.		0.022 REF.	
L1	0.300	0.500	0.012	0.020
θ	0°	8°	0°	8°