

FH1610G

N-Channel Enhancement Mode Power MOSFET

Description

The FH1610G uses advanced trench technology and design to provide excellent $R_{DS(ON)}$ with low gate charge. It can be used in a wide variety of applications.

Applications

- Power Management in Telecom., Industrial Automation, CE
- Current Switching in DC/DC & AC/DC Sub-systems
- Motor Driving in Power Tool, E-vehicle, Robotics

Product Summary

Parameter	Typ.	Unit
V_{DS}	100	V
$V_{GS(th)}$	2.8	V
I_D (@ $V_{GS} = 10V$) ⁽¹⁾	62	A
$R_{DS(ON)}$ (@ $V_{GS} = 10V$)	7.8	mΩ (MAX)

- Ultra-low $R_{DS(ON)}$
- Low Gate Charge
- High Current Capability
- 100% UIS Tested, 100% R_g Tested

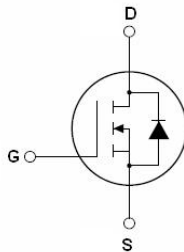

Schematic dia Gram



Marking and pin Assignment

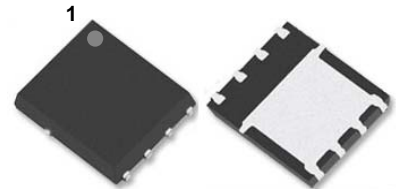

PDFN5x6-8L top and bottom view

Absolute Maximum Ratings (@ $T_A = 25^\circ\text{C}$ unless otherwise specified)

Parameter	Symbol	Value	Unit
Drain-to-Source Voltage	V_{DS}	100	V
Gate-to-Source Voltage	V_{GS}	± 20	V
Continuous Drain Current ⁽¹⁾	I_D	$T_C = 25^\circ\text{C}$	62
		$T_C = 100^\circ\text{C}$	51
Pulsed Drain Current ⁽²⁾	I_{DM}	248	A
Avalanche Current ⁽³⁾	I_{AS}	41	A
Avalanche Energy ⁽³⁾	E_{AS}	101	mJ
Power Dissipation ⁽⁴⁾	P_D	$T_C = 25^\circ\text{C}$	65
		$T_C = 100^\circ\text{C}$	26
Junction & Storage Temperature Range	T_J, T_{STG}	-55 to 150	$^\circ\text{C}$

Electrical Characteristics (@ $T_J = 25^\circ\text{C}$ unless otherwise specified)

Parameter	Symbol	Conditions	Min.	Typ.	Max.	Unit
STATIC PARAMETERS						
Drain-Source Breakdown Voltage	$V_{(BR)DSS}$	$I_D = 250\mu\text{A}, V_{GS} = 0\text{V}$	100			V
Zero Gate Voltage Drain Current	I_{DSS}	$V_{DS} = 80\text{V}, V_{GS} = 0\text{V}$ $T_J = 55^\circ\text{C}$			1.0 5.0	μA
Gate-Body Leakage Current	I_{GSS}	$V_{DS} = 0\text{V}, V_{GS} = \pm 20\text{V}$			± 100	nA
Gate Threshold Voltage	$V_{GS(th)}$	$V_{DS} = V_{GS}, I_D = 250\mu\text{A}$	2.0	2.8	4.0	V
Static Drain-Source ON-Resistance	$R_{DS(on)}$	$V_{GS} = 10\text{V}, I_D = 20\text{A}$		6.2	7.8	$\text{m}\Omega$
Forward Transconductance	g_{FS}	$V_{DS} = 5\text{V}, I_D = 20\text{A}$		51		S
Diode Forward Voltage	V_{SD}	$I_S = 1\text{A}, V_{GS} = 0\text{V}$		0.70	1.0	V
Diode Continuous Current	I_S	$T_C = 25^\circ\text{C}$			55	A
DYNAMIC PARAMETERS ⁽⁵⁾						
Input Capacitance	C_{iss}	$V_{GS} = 0\text{V}, V_{DS} = 50\text{V}, f = 1\text{MHz}$		1920		pF
Output Capacitance	C_{oss}			445		pF
Reverse Transfer Capacitance	C_{rss}			7.0		pF
Gate Resistance	R_g	$V_{GS} = 0\text{V}, V_{DS} = 0\text{V}, f = 1\text{MHz}$		1.5		Ω
SWITCHING PARAMETERS ⁽⁵⁾						
Total Gate Charge (@ $V_{GS} = 10\text{V}$)	Q_g	$V_{GS} = 0 \text{ to } 10\text{V}$ $V_{DS} = 50\text{V}, I_D = 13\text{A}$		30		nC
Total Gate Charge (@ $V_{GS} = 6.0\text{V}$)	Q_g			20		nC
Gate Source Charge	Q_{gs}			6.9		nC
Gate Drain Charge	Q_{gd}			8.4		nC
Turn-On Delay Time	$t_{D(on)}$	$V_{GS} = 10\text{V}, V_{DS} = 50\text{V}$ $R_L = 3.8\Omega, R_{GEN} = 6\Omega$		8.5		ns
Turn-On Rise Time	t_r			9.7		ns
Turn-Off Delay Time	$t_{D(off)}$			29		ns
Turn-Off Fall Time	t_f			19.1		ns
Body Diode Reverse Recovery Time	t_{rr}		$I_F = 13\text{A}, dI_F/dt = 100\text{A}/\mu\text{s}$		52	
Body Diode Reverse Recovery Charge	Q_{rr}	$I_F = 13\text{A}, dI_F/dt = 100\text{A}/\mu\text{s}$		55		nC

Thermal Performance

Parameter	Symbol	Typ.	Max.	Unit
Thermal Resistance, Junction-to-Ambient	$R_{\theta JA}$	50	65	$^\circ\text{C}/\text{W}$
Thermal Resistance, Junction-to-Case	$R_{\theta JC}$	0.85	1.0	$^\circ\text{C}/\text{W}$

Notes:

1. Computed continuous current assumes the condition of T_{J_Max} while the actual continuous current depends on the thermal & electro-mechanical application board design.
2. This single-pulse measurement was taken under $T_{J_Max} = 150^\circ\text{C}$.
3. This single-pulse measurement was taken under the following condition [$L = 100\mu\text{H}, V_{GS} = 10\text{V}, V_{DS} = 50\text{V}$] while its value is limited by $T_{J_Max} = 150^\circ\text{C}$.
4. The power dissipation P_D is based on $T_{J_Max} = 150^\circ\text{C}$.
5. This value is guaranteed by design hence it is not included in the production test.
6. Continuous current rating is limited by the package used.

Typical Electrical & Thermal Characteristics

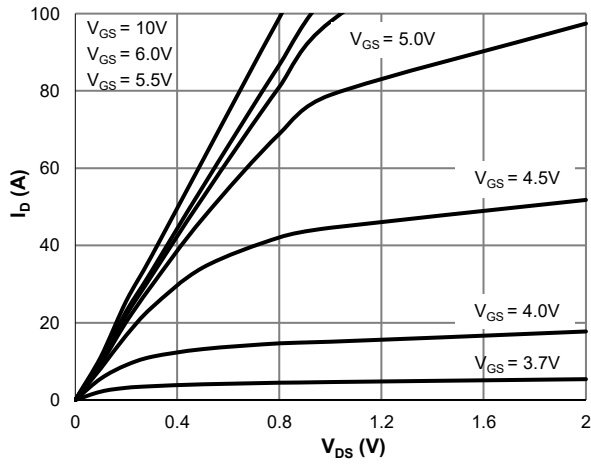

Figure 1: Saturation Characteristics

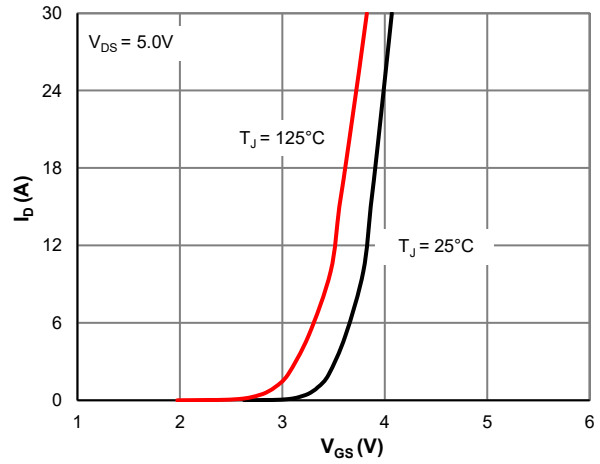

Figure 2: Transfer Characteristics

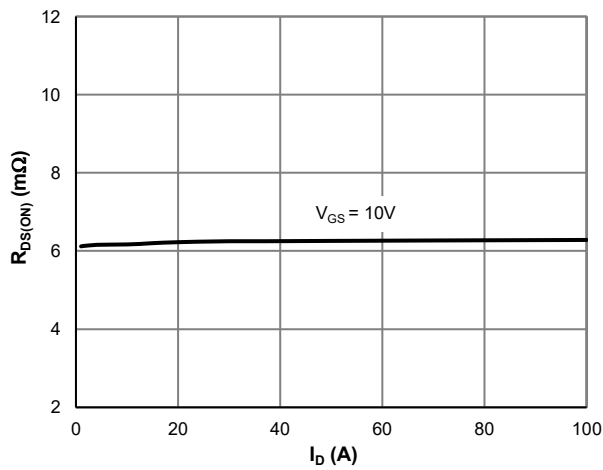

Figure 3: $R_{DS(ON)}$ vs. Drain Current

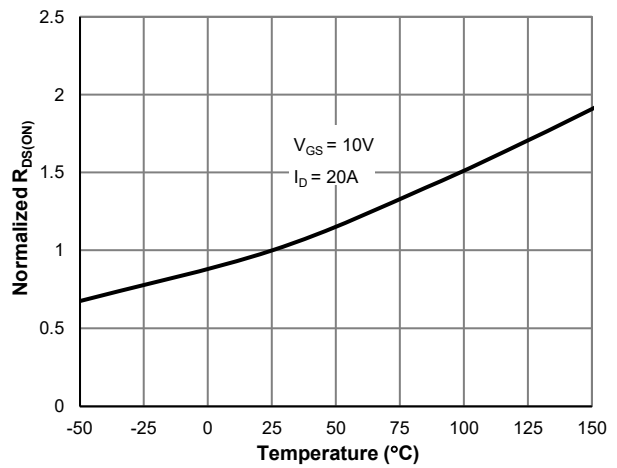

Figure 4: $R_{DS(ON)}$ vs. Junction Temperature

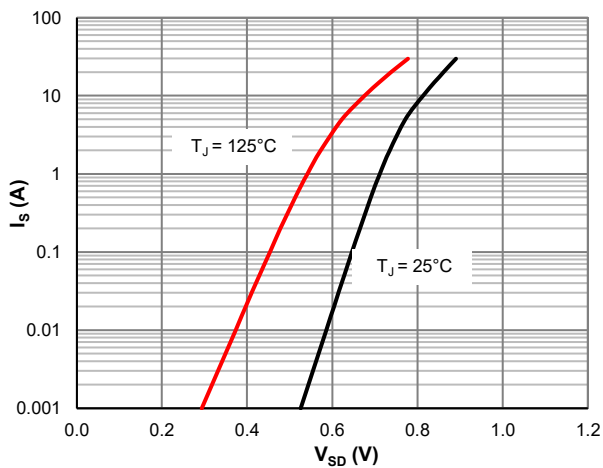

Figure 5: Body-Diode Characteristics

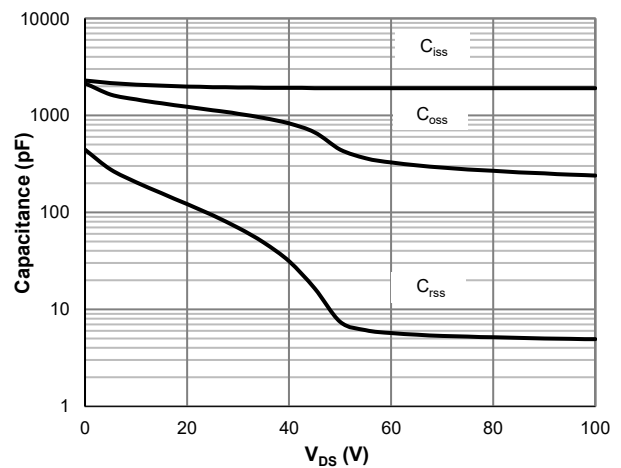

Figure 6: Capacitance Characteristics

Typical Electrical & Thermal Characteristics

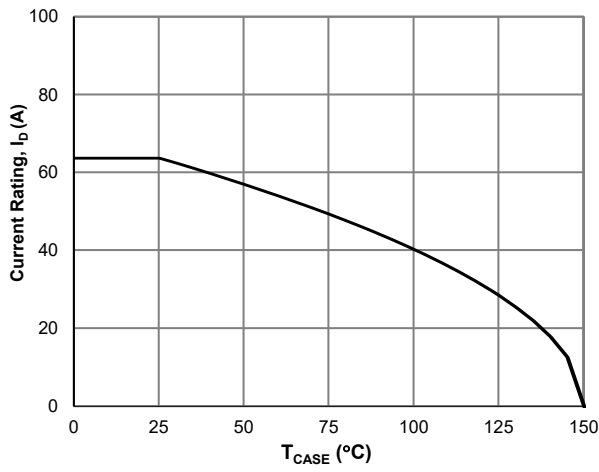

Figure 7: Current De-rating

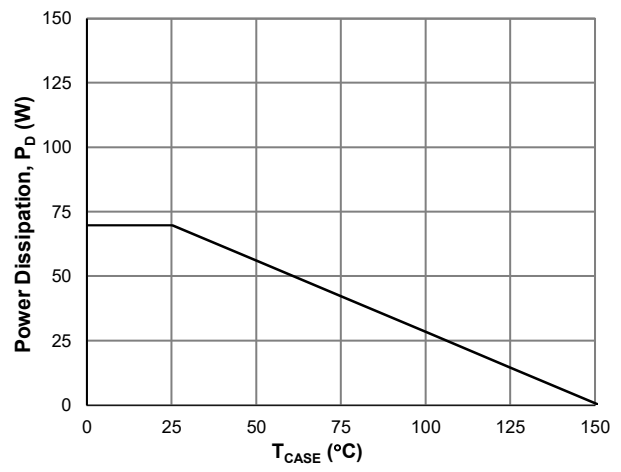

Figure 8: Power De-rating

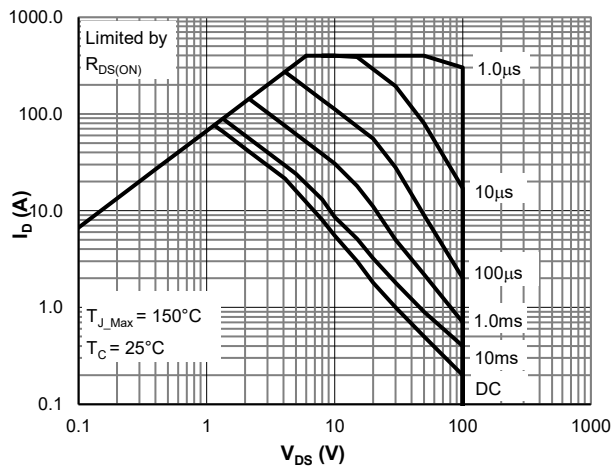

Figure 9: Maximum Safe Operating

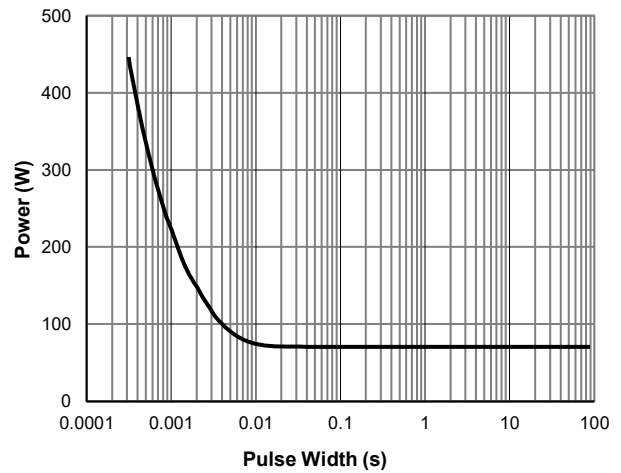
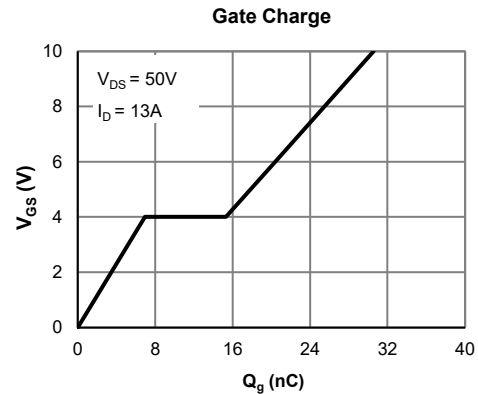
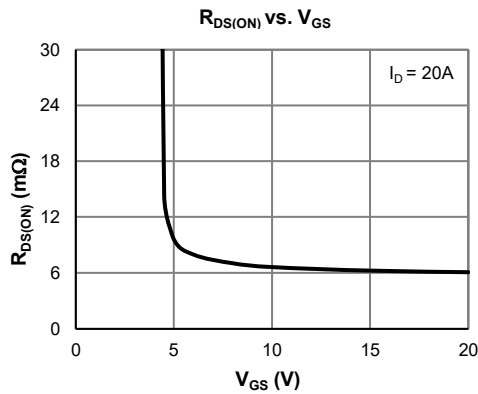

Figure 10: Single Pulse Power Rating, Junction-to-Case



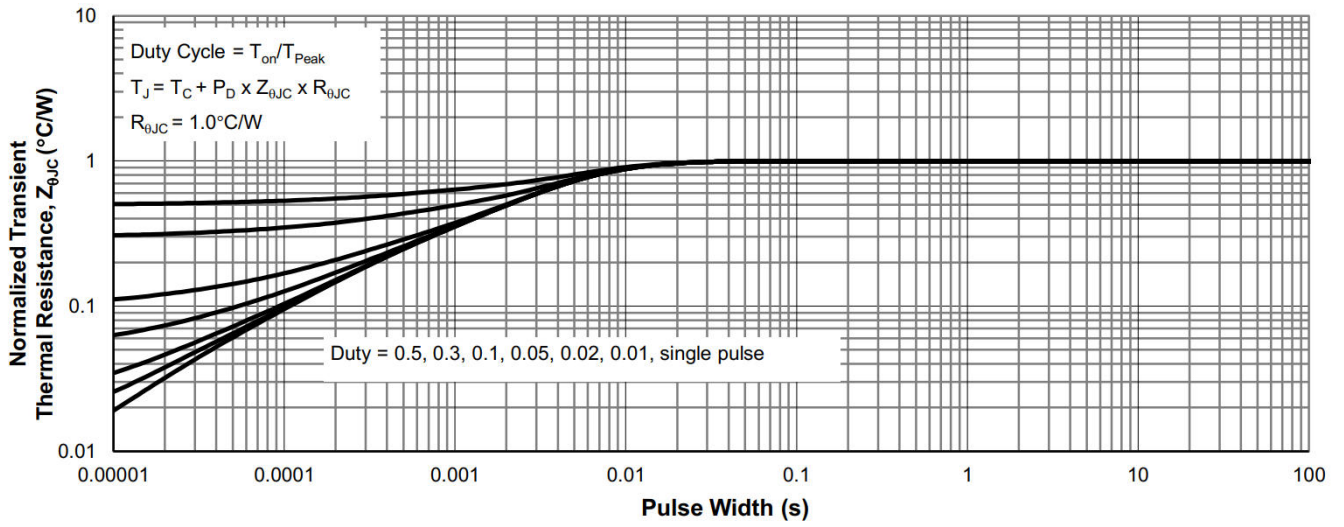
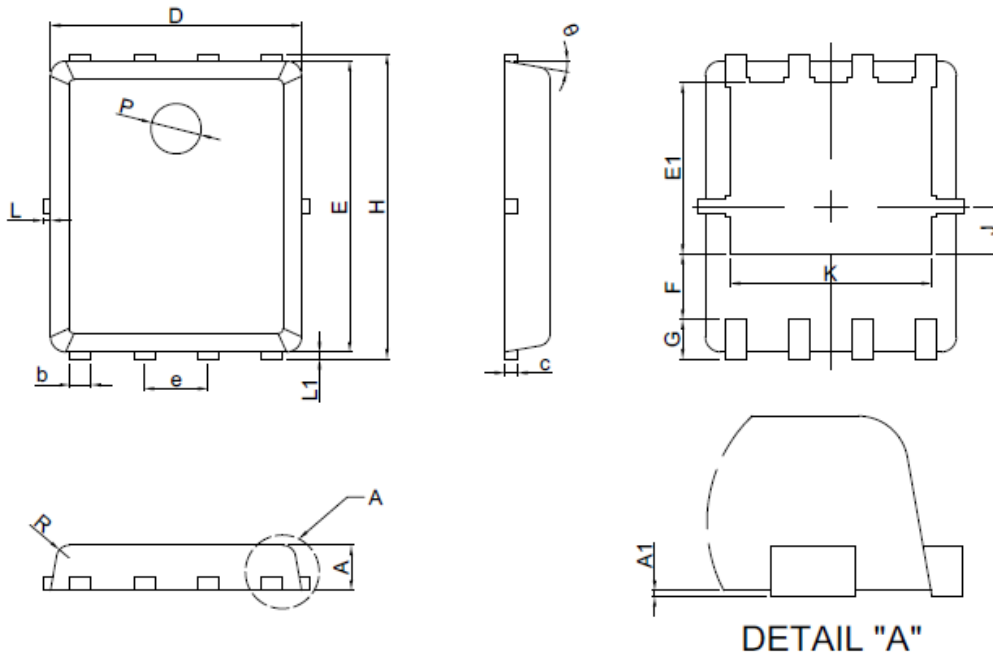

Figure 11: Normalized Maximum Transient Thermal Impedance

Package Information : PDFN5x6-8L



Symbol	Dimensions In Millimeters	
	MIN.	MAX.
A	0.80	1.00
A1	0.00	0.05
b	0.35	0.49
c	0.254REF	
D	4.80	5.20
F	1.40REF	
E	5.60	5.90
e	1.27BSC	
H	5.80	6.20
L1	0.10	0.18
G	0.60REF	
K	4.00REF	
L	-	0.15
J	0.95BSC	
P	1.00REF	
E1	3.40REF	
θ	6°	14°
R	0.25REF	