

FH3415G+

P-Channel Enhancement Mode Power MOSFET

Description

The FH3415G+ uses advanced trench technology to provide excellent $R_{DS(ON)}$, low gate charge and operation with gate voltages as low as 1.8V. This device is suitable for use as a load switch or in PWM applications. It is ESD protected.

Application

- PWM application
- Load switch

General Features

- $V_{DS} = -20V, I_D = -4.5A$
 $R_{DS(ON)} < 29m\Omega$ (Typ.) @ $V_{GS} = -4.5V$
 $R_{DS(ON)} < 41m\Omega$ (Typ.) @ $V_{GS} = -2.5V$
- High Power and current handling capability
- Lead free product is acquired
- Surface mount package
- ESD Rating : HBM Class 3A
 (3A : ESD Voltage Range 4000~8000V)

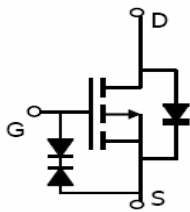

Schematic diagram

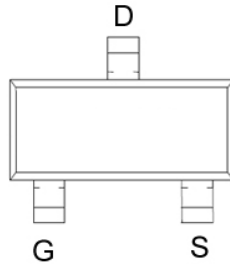

Marking and Pin Assignment

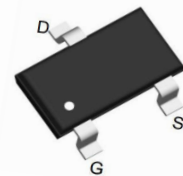

SOT-23 top view

Absolute Maximum Ratings (TA=25°C unless otherwise noted)

Parameter	Symbol	Limit	Unit
Drain-Source Voltage	V_{DS}	-20	V
Gate-Source Voltage	V_{GS}	±10	V
Drain Current-Continuous	I_D	-4.5	A
Drain Current-Pulsed (Note 1)	I_{DM}	-17.6	A
Maximum Power Dissipation	P_D	1.25	W
Operating Junction and Storage Temperature Range	T_J, T_{STG}	-55 To 150	°C

Thermal Characteristic

Thermal Resistance, Junction-to-Ambient (Note 2)	$R_{\theta JA}$	100	°C/W
--	-----------------	-----	------

Electrical Characteristics (TA=25°C unless otherwise noted)

Parameter	Symbol	Condition	Min	Typ	Max	Unit
Off Characteristics						
Drain-Source Breakdown Voltage	BV_{DSS}	$V_{GS}=0V, I_D=-250\mu A$	-20	-22	-	V
Zero Gate Voltage Drain Current	I_{DSS}	$V_{DS}=-20V, V_{GS}=0V$	-	-	1	μA
Gate-Body Leakage Current	I_{GSS}	$V_{GS}=\pm 10V, V_{DS}=0V$	-	-	± 10	μA
On Characteristics (Note 3)						
Gate Threshold Voltage	$V_{GS(th)}$	$V_{DS}=V_{GS}, I_D=-250\mu A$	-0.45	-0.7	-1.1	V
Drain-Source On-State Resistance	$R_{DS(on)}$	$V_{GS}=-4.5V, I_D=-4A$	-	29	39	m Ω
		$V_{GS}=-2.5V, I_D=-2A$	-	41	54	m Ω
Forward Transconductance	g_{FS}	$V_{DS}=-5V, I_D=-4A$	-	17	-	S
Dynamic Characteristics (Note4)						
Input Capacitance	C_{iss}	$V_{DS}=-10V, V_{GS}=0V,$ $F=1.0MHz$	-	995	-	PF
Output Capacitance	C_{oss}		-	187	-	PF
Reverse Transfer Capacitance	C_{rss}		-	142	-	PF
Switching Characteristics (Note 4)						
Turn-on Delay Time	$t_{d(on)}$	$V_{DD}=-10V, R_L=2.5\Omega$ $V_{GS}=-4.5V, R_{GEN}=3\Omega$	-	9.5		nS
Turn-on Rise Time	t_r		-	17		nS
Turn-Off Delay Time	$t_{d(off)}$		-	35		nS
Turn-Off Fall Time	t_f		-	20		nS
Total Gate Charge	Q_g	$V_{DS}=-10V, I_D=-4A,$ $V_{GS}=-4.5V$	-	17.4		nC
Gate-Source Charge	Q_{gs}		-	1.3	-	nC
Gate-Drain Charge	Q_{gd}		-	4.5	-	nC
Drain-Source Diode Characteristics						
Diode Forward Voltage (Note 3)	V_{SD}	$V_{GS}=0V, I_S=-1A$	-	-0.78	-1	V
Diode Forward Current (Note 2)	I_S		-	-	-4	A

Notes:

1. Repetitive Rating: Pulse width limited by maximum junction temperature.
2. Surface Mounted on FR4 Board, $t \leq 10$ sec.
3. Pulse Test: Pulse Width $\leq 300\mu s$, Duty Cycle $\leq 2\%$.
4. Guaranteed by design, not subject to production

TYPICAL ELECTRICAL AND THERMAL CHARACTERISTICS

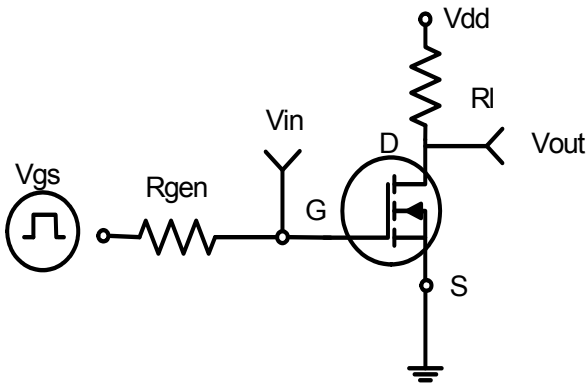

Figure 1: Switching Test Circuit

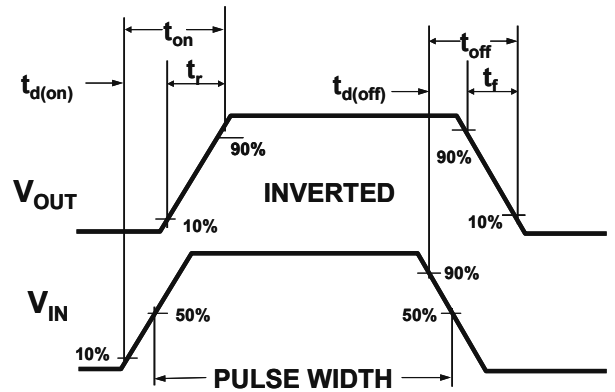

Figure 2: Switching Waveforms

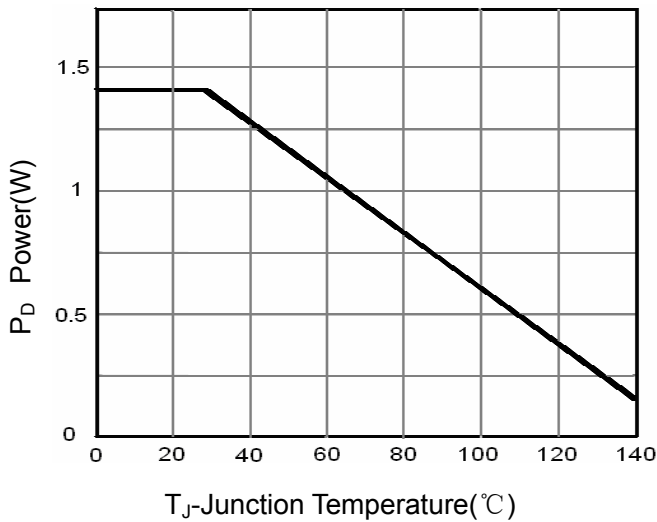

Figure 3 Power Dissipation

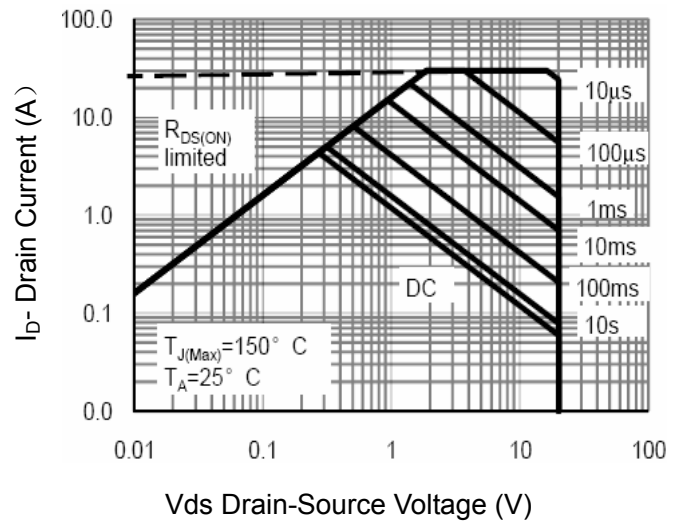

Figure 4 Safe Operation Area

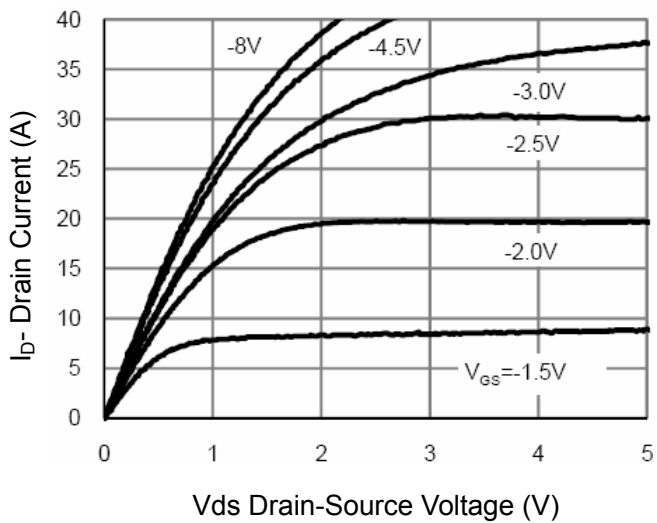

Figure 5 Output CHARACTERISTICS

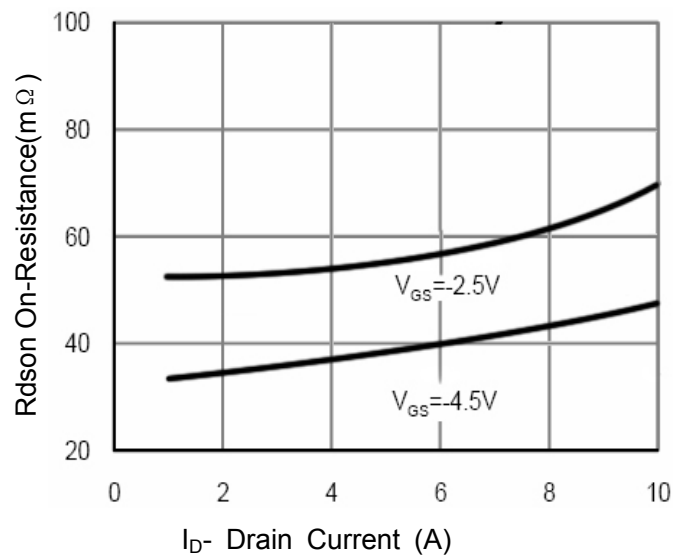

Figure 6 Drain-Source On-Resistance

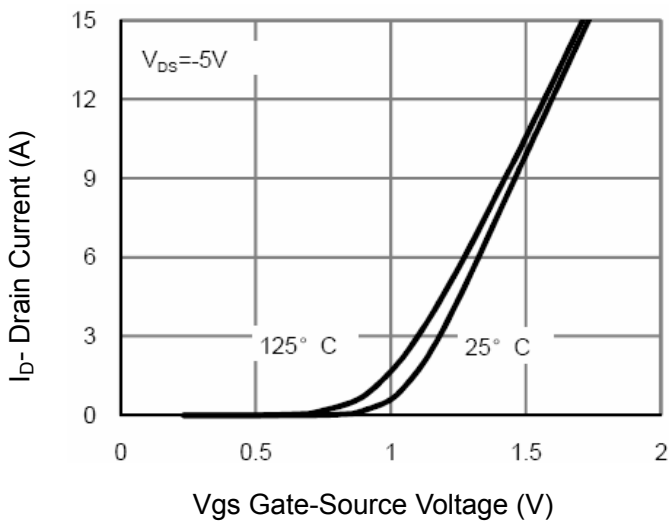

Figure 7 Transfer Characteristics

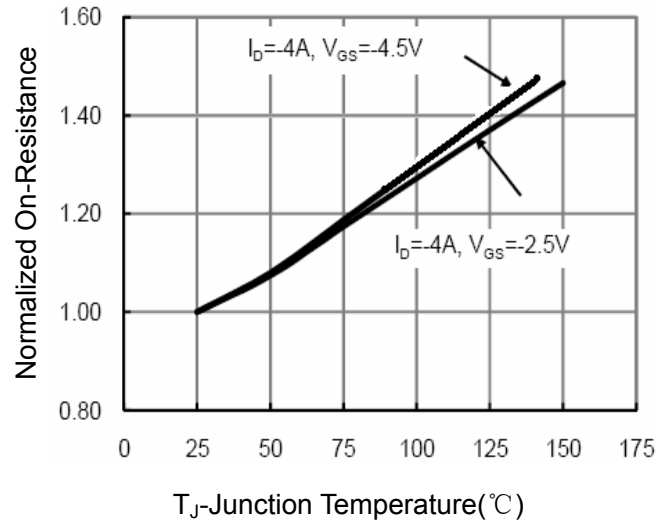

Figure 8 Drain-Source On-Resistance

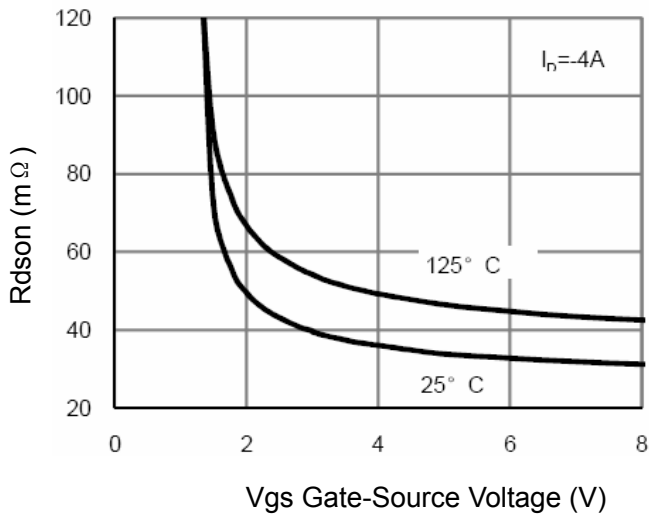

Figure 9 Rdson vs Vgs

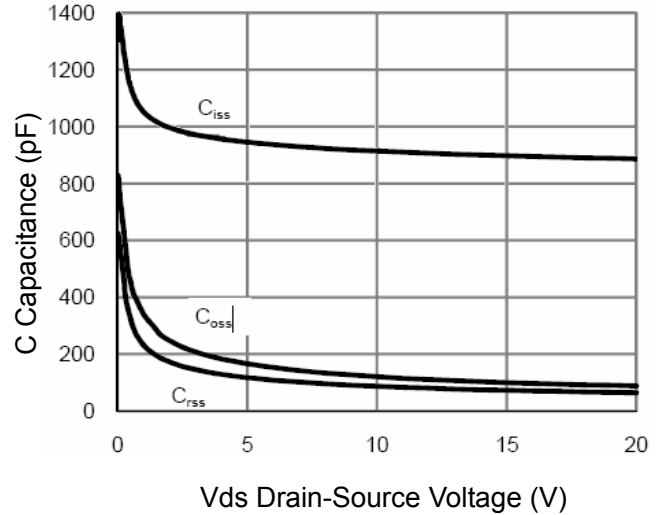

Figure 10 Capacitance vs Vds

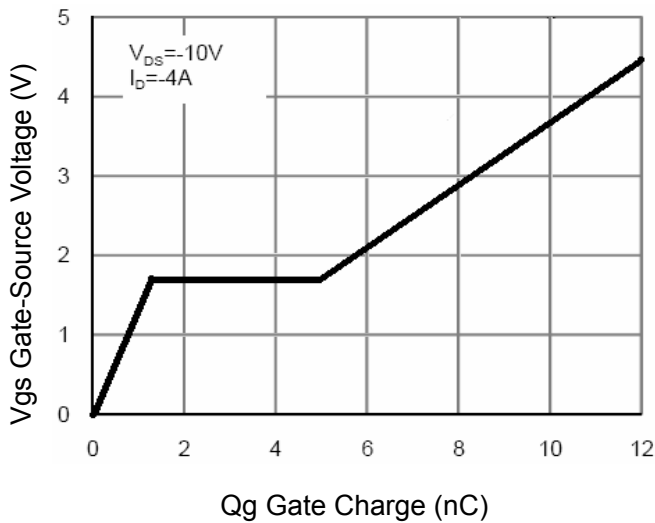

Figure 11 Gate Charge

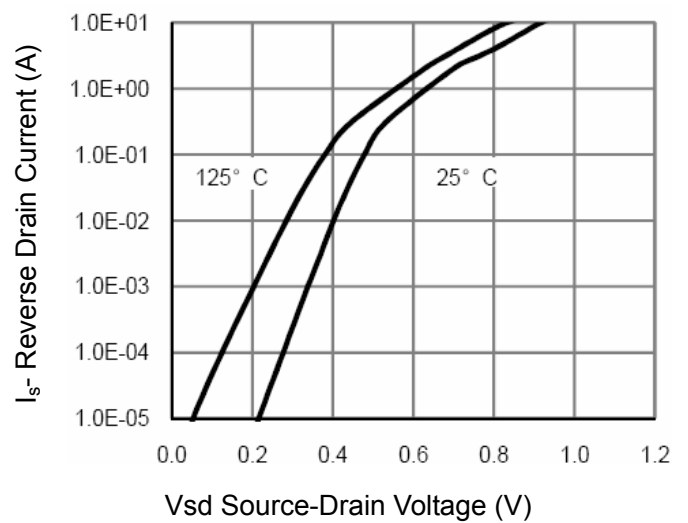

Figure 12 Source- Drain Diode Forward

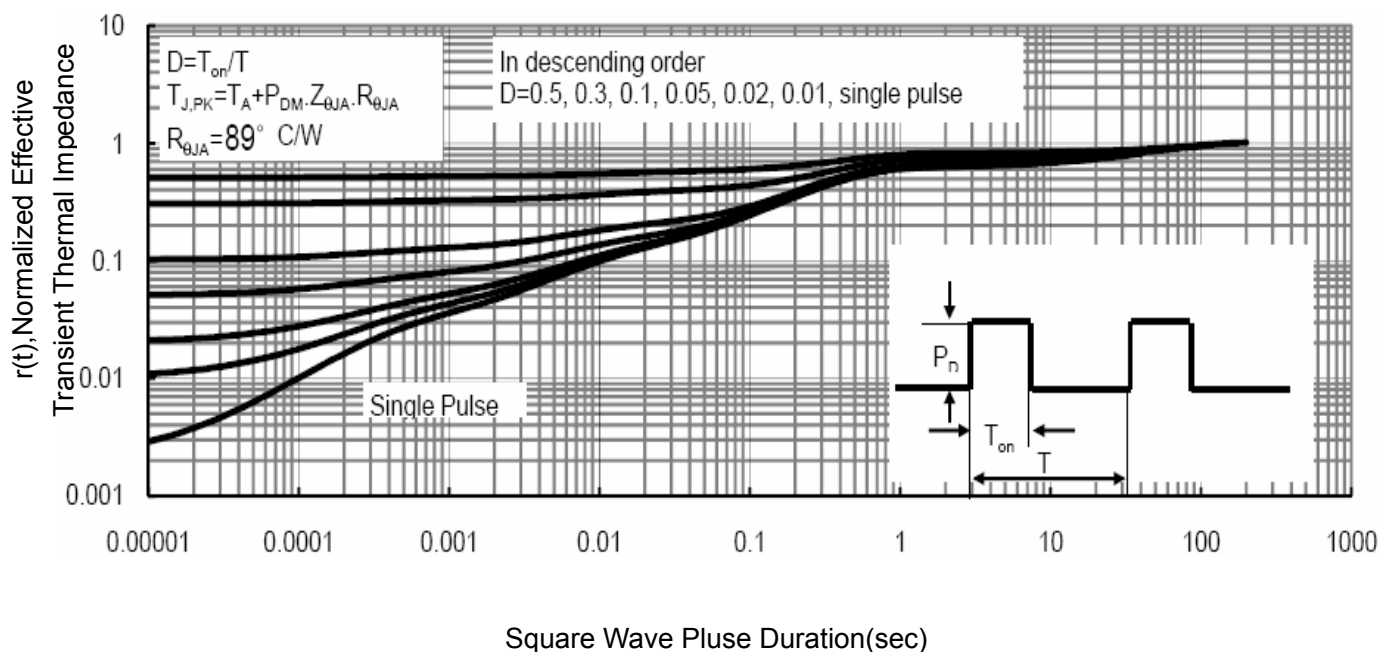
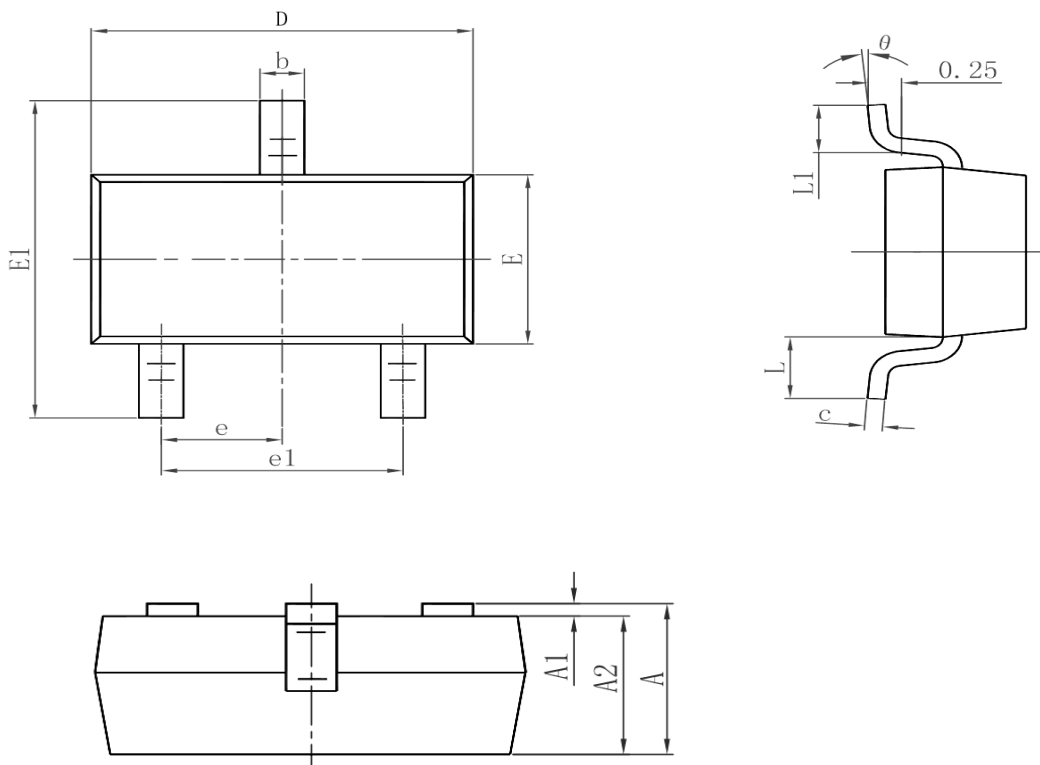

Figure 13 Normalized Maximum Transient Thermal Impedance

■ Package Dimensions : SOT-23



Symbol	Dimensions In Millimeters		Dimensions In Inches	
	Min.	Max.	Min.	Max.
A	0.900	1.150	0.035	0.045
A1	0.000	0.100	0.000	0.004
A2	0.900	1.050	0.035	0.041
b	0.300	0.500	0.012	0.020
c	0.080	0.150	0.003	0.006
D	2.800	3.000	0.110	0.118
E	1.200	1.400	0.047	0.055
E1	2.250	2.550	0.089	0.100
e	0.950 TYP.		0.037 TYP.	
e1	1.800	2.000	0.071	0.079
L	0.550 REF.		0.022 REF.	
L1	0.300	0.500	0.012	0.020
θ	0°	8°	0°	8°