

FH8205A

N-Channel Enhancement Mode

General Description

The FH8205A uses advanced technology to provide fast switching, low on-resistance and cost-effectiveness. This device is suitable for all commercial industrial surface mount applications.

Features

- $R_{DS(ON)} \leq 26m\Omega @ V_{GS} = 4.5V$
- Ultra low gate charge (typical 23nC)
- Low reverse transfer Capacitance (C_{RSS} = typical 150pF)
- Fast switching capability
- Advanced energy Specified
- Improved dv/dt capability, high ruggedness

CPC-8

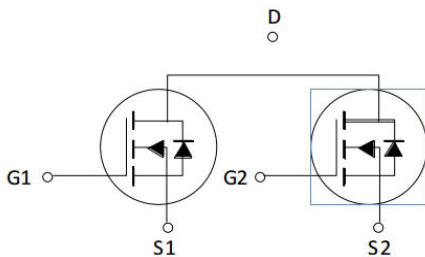

Schematic diagram

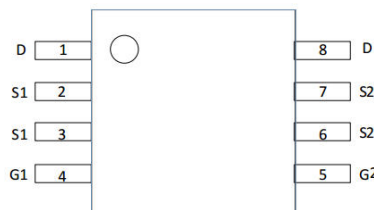

Marking and pin Assignment

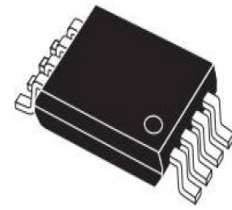

CPC-8 top view

Absolute Maximum Ratings

PARAMETER	SYMBOL	RATINGS	UNIT	
Drain-Source Voltage	V_{DSS}	20	V	
Gate-Source voltage	V_{GSS}	± 12	V	
Drain Current (Note 2)	Continuous	I_D	6	A
	Pulsed	I_{DM}	20	A
Power Dissipation ($T_a = 25^\circ C$) (Note 3)	P_D	1	W	
Junction to Ambient (Note 2)	θ_{JA}	125	$^\circ C/W$	
Junction Temperature	T_J	+150	$^\circ C$	
Storage Temperature	T_{STG}	-55 to +150	$^\circ C$	

Note: 1. Absolute maximum ratings are those values beyond which the device could be permanently damaged.

Absolute maximum ratings are stress ratings only and functional device operation is not implied.

2. Pulse Test: Pulse width $\leq 300\mu s$, Duty cycles $\leq 2\%$

3. Pulse width limited by $T_{J(MAX)}$

Electrical Characteristics

T_J=25° C unless otherwise specified

PARAMETER	STMBOL	TEST CONDITIONS	MIN	TYP	MAX	UNIT
OFF CHARACTERISTIC						
Drain-Source Breakdown Voltage	BV _{DSS}	V _{GS} =0V, I _D =250μA	20			V
Breakdown Voltage Temperature Coefficient	$\frac{\Delta BV_{DSS}}{\Delta T_J}$	I _D =1mA, Reference to 25°C		0.03		V/°C
Drain Source Leakage Current	I _{DSS}	V _{DS} =16V V _{GS} =0V			1	μA
Gate-Source Leakage Current	I _{GSS}	V _{GS} =±8V			±100	nA
ON CHARACTERISTICS						
Gate Threshold Voltage	V _{GS(TH)}	V _{DS} =V _{GS} , I _D =250μA	0.45	0.65	1	V
Drain-Source On-State Resistance(Note)	R _{DS(ON)}	V _{GS} =4.5V, I _D =4.5A		20	26	mΩ
		V _{GS} =2.5V, I _D =3.5A		26	31	mΩ
DYNAMIC PARAMETERS						
Input Capacitance	C _{ISS}	V _{DS} =20V, V _{GS} =4.5V, I _D =250μA		1035		pF
Output Capacitance	C _{OSS}			320		pF
Reverse Transfer Capacitance	C _{RSS}			150		pF
SWITCHING PARAMETERS						
Turn-On Delay Time(Note)	t _{D(ON)}	V _{GS} =5V, V _{DS} =10V, R _D =250μA, R _G =6Ω, I _D =1A		30		ns
Turn-On Rise Time	t _R			70		ns
Turn Off Delay Time	t _{D(OFF)}			40		ns
Turn-Off Rise Time	t _F			65		ns

Electrical Characteristics (Continued)

T_J=25° C unless otherwise specified

PARAMETER	STMBOL	TEST CONDITIONS	MIN	TYP	MAX	UNIT
Total Gate Charge(Note)	Q _G	V _{DS} =20V, V _{GS} =5V, I _D =6.0A		23		nC
Gate Source Charge	Q _{GS}			4.5		nC
Gate Drain Charge	Q _{GD}			7		nC
SOURCE-DRAIN DIODE RATINGS AND CHARACTERISTICS						
Drain-Source Diode Forward Voltage(Note)	V _{SD}	I _S =1.7A, V _{GS} =0V			1.2	V
Diode Continuous Forward Current	I _S	V _D =V _G , V _S =1.3V			1.54	A

Note: Surface mounted on 1 in2 copper pad of FR4 board; 208° C/W when mounted on min.

Typical Characteristics

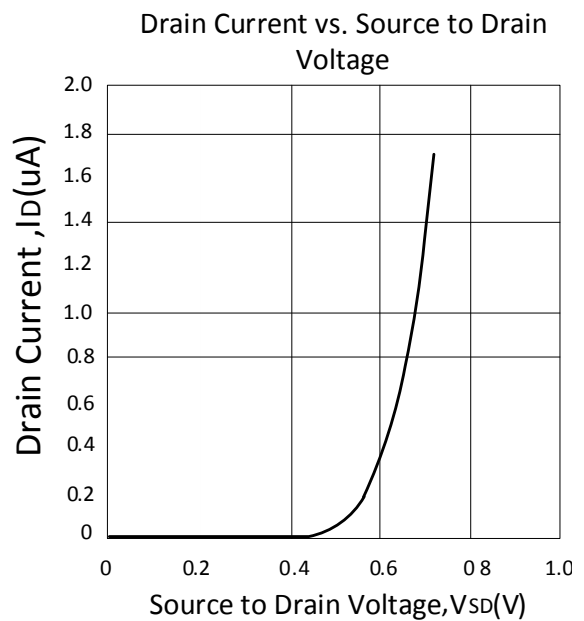
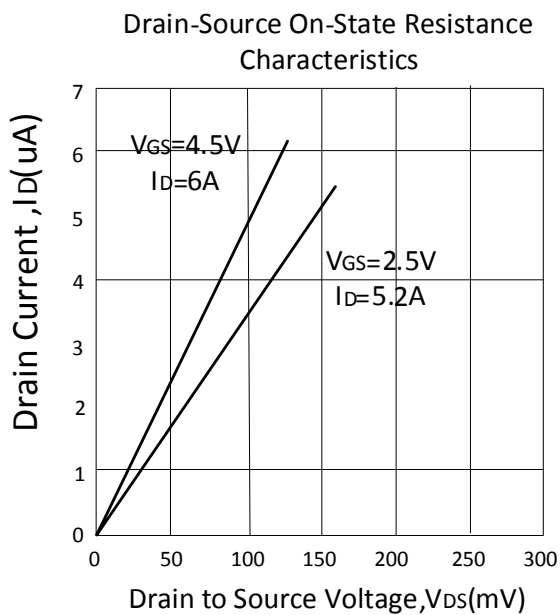
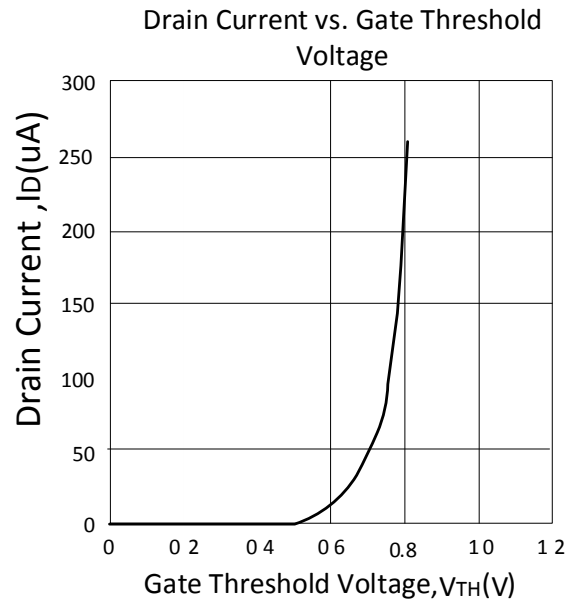
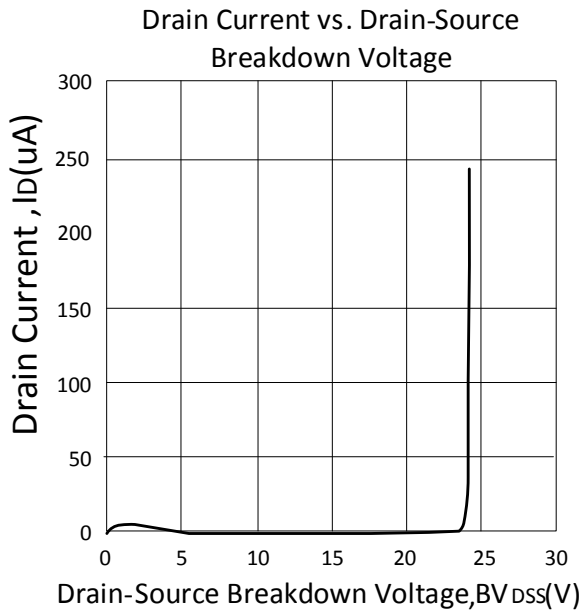

MARKING DESCRIPTION

CPC-8



NOTE:

AAAA : Internal Code

BB : Year Code

CC : Week Code

Package Outline : CPC-8

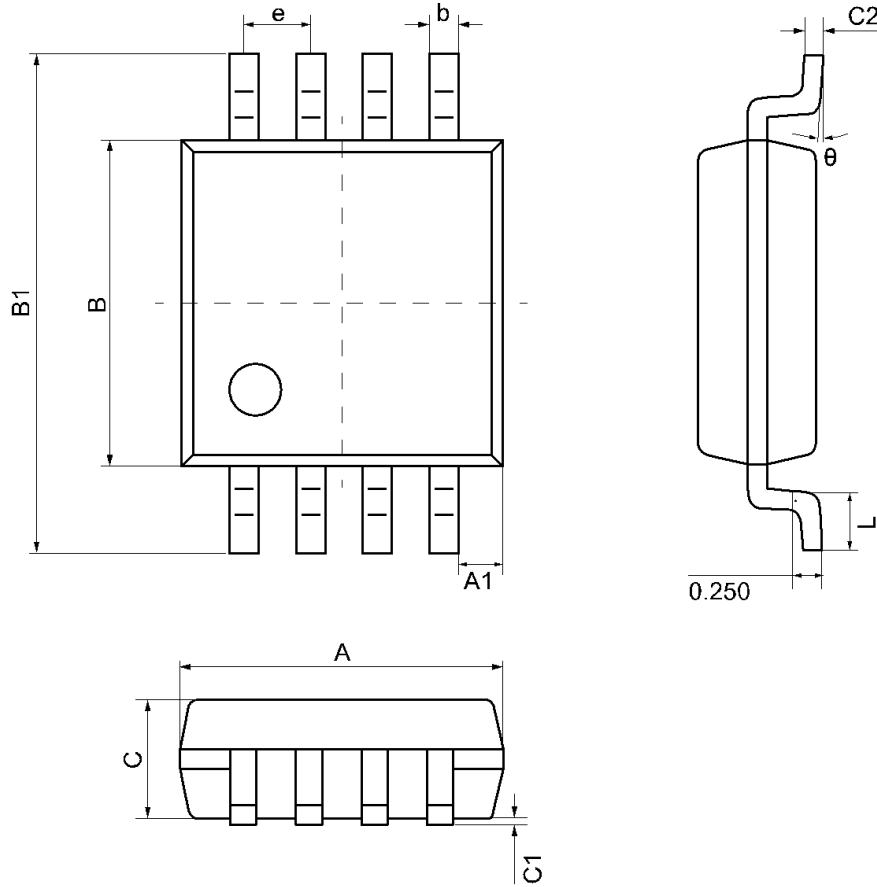

SYMBOL	MIN(mm)	MAX(mm)	SYMBOL	MIN(mm)	MAX(mm)
A	2.50	2.70	C	0.85	1.05
A1	0.35	0.45	C1	0.00	0.15
e	0.53(BSC)		C2	0.15	0.18
B	2.50	2.70	L	0.40	0.60
B1	3.85	4.15	theta	0°	8°
b	0.16	0.26			